

SPD-151

48CH Network Video Decoder



Key Features

- Video decoding up to 48 cameras on HDMI / VGA
- 1 camera decoding on BNC
- Max. 4K resolution@HDMI, Max. 1080p@VGA
- Various view mode
 - (HDMI) 1 / 2x2 / 3x3 / 4x4 / 5x5 / 6x6 (32Ch Only)
 - (VGA) 1 / 2x2 / 3x3 / 4x4
 - (BNC) 1 Tile merge support
- Up to 49CH, H.265 / H.264 / MJPEG codec
- Layout Sequence Support
- Management using Web-Viewer
- 12VDC, PoE

Dimensions

Unit : mm (inch)

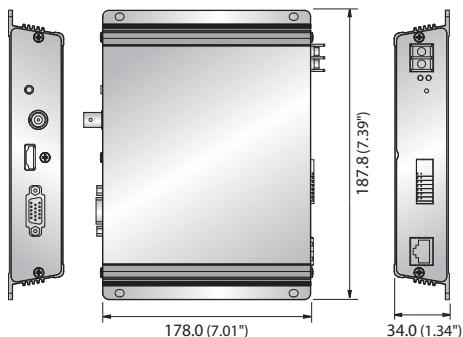

SPD-151

NETWORK		
CPU	Embedded CPU	
Operating System	Embedded Linux	
Output	HDMI	1ea (up-to 4K)
	VGA	1ea (up-to 1080p)
	CVBS	1ch (BNC 1ea)
Video-out Format		3840 X 2160@60HZ/30HZ (HDMI1), 2560 X 1440@60HZ/30HZ (HDMI1), 1920 X 1080@60HZ, 1280 X 1024@60H, 1280 X 720@60Hz
External	Ethernet	1ea (10/100/1000BASE-T)
	USB	USB 2.0 2ea
	Audio Out	1 out
	LED	Power, Network
ENVIRONMENTAL		
Operating Temperature	0°C ~ +40C (+32°F ~ +104°F)	
Humidity	20% ~ 85% RH	
ELECTRICAL		
Power	12V DC, PoE (IEEE802.3af)	
Power Consumption	Max. 21.6W (12V DC), Max. 12.95W (PoE)	
MECHANICAL		
Color / Material	Dark Gray / Metal	
Dimension (WxHxD)	178.0 x 34.0 x 187.8mm (7.01" x 1.34" x 7.39")	
Weight	Approx. 0.68Kg (1.50 lb)	
SOFTWARE		
Video	Codec	H.265/H.264/MJPEG
	Max. Decoding Performance	16 X 2M (1080P)@30fp, 8MP@30fps
	Max. Decoding Resolution	Up-to 12MP
	Max. Decoding Bandwidth	200Mbps
	Division (/Monitor)	(HDMI) 1/2x2/3x3/4x4/5x5/6x6(32Ch Only) (VGA) 1/2x2/3x3/4x4 (BNC) 1
	Layout	Up-to 20ea/monitor, Sequence support
Merge	Monitor Merge	1x2, 2x1
	Tile Merge	Support
Audio	Codec	G.711/G.726/AAC
Management		Web-Viewer, SSM
Time Setting		NTP / Manual
Export / Import		Configuration Export/Import
Log		Max.20000 (System log, Event log each)
Protocol		Over SUNAPI 2.3

* The latest product information / specification can be found at hanwha-security.com
 * Design and specifications are subject to change without notice.
 * Wisenet is the proprietary brand of Hanwha Techwin.